

# DM - Series DIMM Sockets

## vertical type 100-pin 4bit



DIMM sockets are only available as long latch type  
( Module locking extractors ).

Insertion & extraction of the module can be made without any tools.

Positive polarization prevents wrong insertion of the module.

Contacts are designed with an anti-overstress feature for long contact life. Selective Gold/Tin plated. Gold only in contact area.

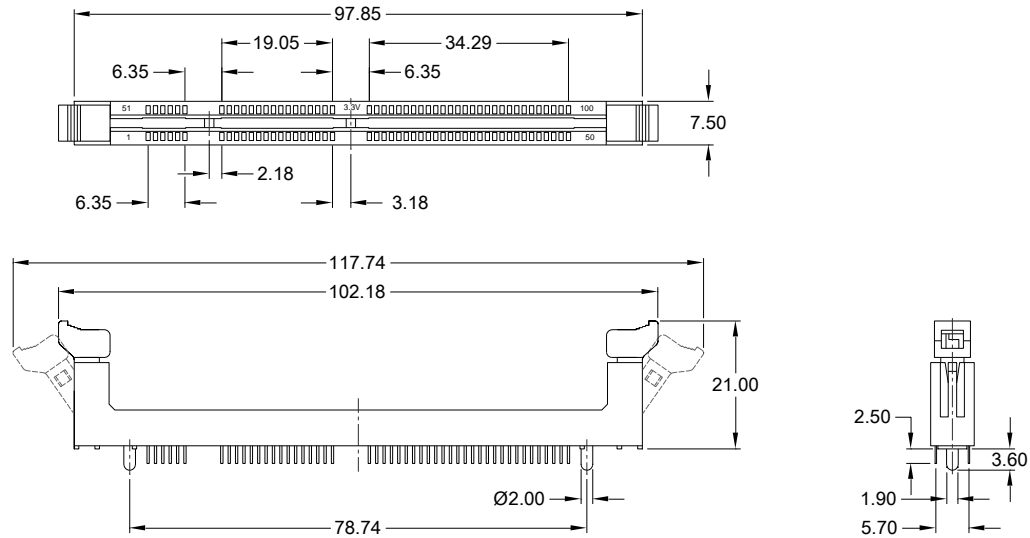
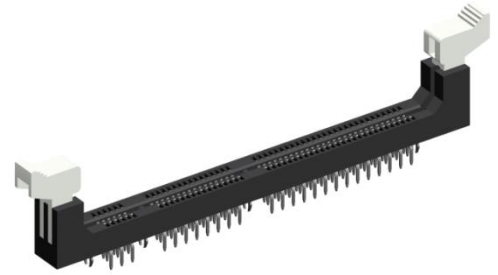

### PC Board hole layout

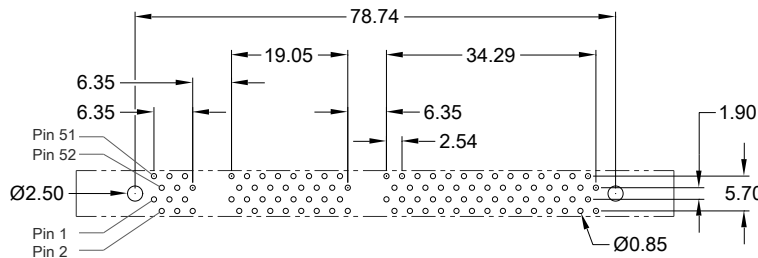

#### Module keying Type "A"

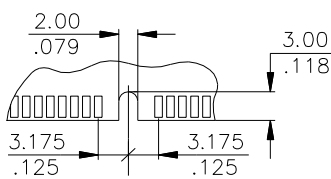

#### Module keying Type "B"

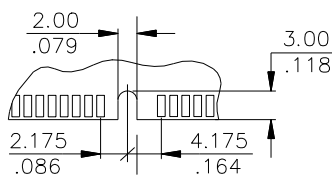

#### Module keying Type "C"

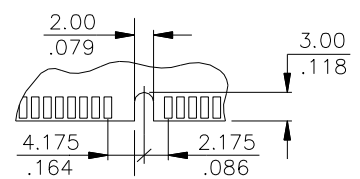

### Specification

Current rating 1 A max., 250V AC  
Contact resistance 30 mΩ max.  
Withstanding voltage 500V AC / Minute  
Insulation resistance 1000 MΩ min.

Operating temperature -25° C to +105° C  
Insulator (RoHS compliant) PA UL 94 V-0  
Contact (RoHS compliant) Copper Alloy  
Plating Au / Sn (leadfree) over Ni

Pin	Socket Type	Key No. 1	Key No. 2	Ordering Code
100 pin	DRAM 5 Volt	Type "A"	Type "B"	Please contact E-tec sales office for availability.
100 pin	SDRAM 5 Volt	Type "B"	Type "B"	Please contact E-tec sales office for availability.
100 pin	UDRAM 5 Volt	Type "C"	Type "B"	Please contact E-tec sales office for availability.
100 pin	DRAM 3,3 Volt	Type "A"	Type "A"	Please contact E-tec sales office for availability.
100 pin	SDRAM 3,3 Volt	Type "B"	Type "A"	Please contact E-tec sales office for availability.
100 pin	UDRAM 3,3 Volt	Type "C"	Type "A"	<b>DM1 - 100 - VCA9/A - 95/1L</b>

DIMM sockets are only available as long latch type  
( Module locking extractors ).

Insertion & extraction of the module can be made without any tools.

Positive polarization prevents wrong insertion of the module.

Contacts are designed with an anti-overstress feature for long contact life. Selective Gold/Tin plated. Gold only in contact area.

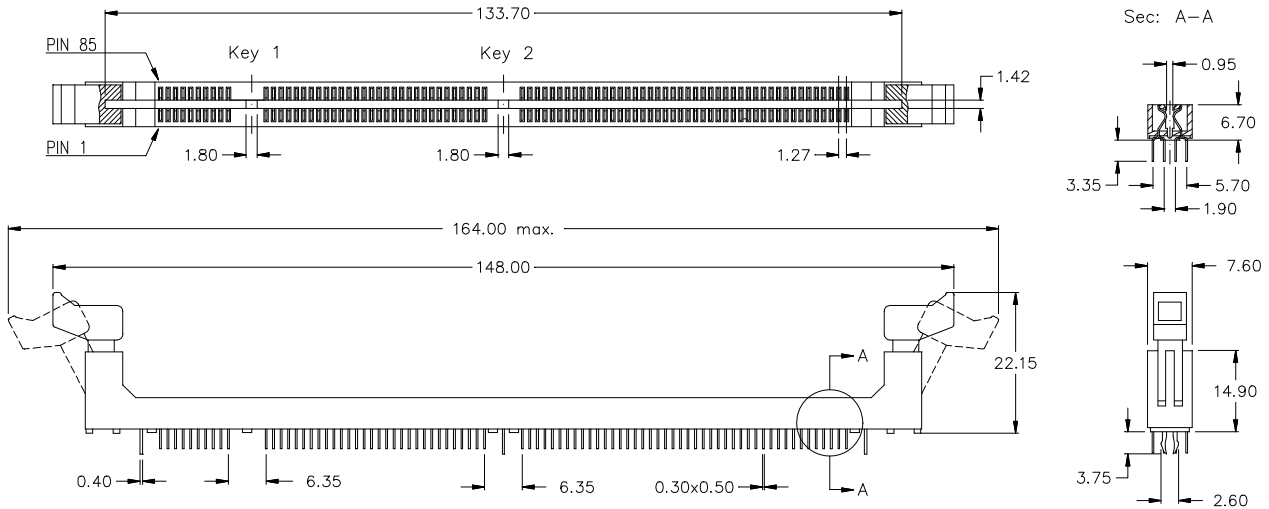

PC Board hole layout

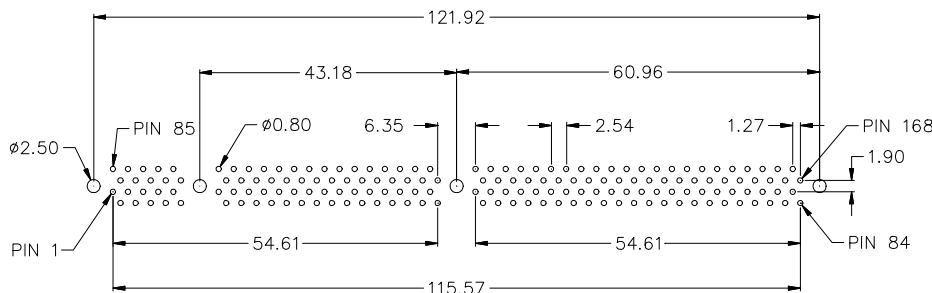

Module keying Type "A"

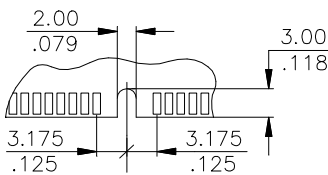

Module keying Type "B"

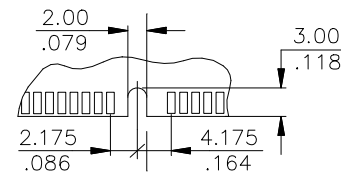

Module keying Type "C"

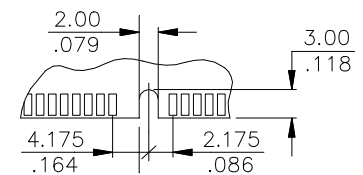

Specification

Current rating	1 A max., 250V AC	Operating temperature	-55° C to +105° C min.
Contact resistance	30 mΩ max.	Insulator (RoHS compliant)	high temp plastic UL 94 V-0
Breakdown voltage	1,5 KV RMS max.	Contact (RoHS compliant)	Copper Alloy
Insulation resistance	10 <sup>4</sup> MΩ min.	Plating	Au / Sn (leadfree) over Ni
Capacitance	1 pF max.		

Pin	Socket Type	Key No. 1	Key No. 2	Ordering Code
168 pin	DRAM 5 Volt	Type "A"	Type "B"	<b>DM1 - 168 - VAB9 - 95/1L</b>
168 pin	SDRAM 5 Volt	Type "B"	Type "B"	<b>DM1 - 168 - VBB9 - 95/1L</b>
168 pin	UDRAM 5 Volt	Type "C"	Type "B"	<b>DM1 - 168 - VCB9 - 95/1L</b>
168 pin	DRAM 3,3 Volt	Type "A"	Type "A"	<b>DM1 - 168 - VAA9 - 95/1L</b>
168 pin	SDRAM 3,3 Volt	Type "B"	Type "A"	<b>DM1 - 168 - VBA9 - 95/1L</b>
168 pin	UDRAM 3,3 Volt	Type "C"	Type "A"	<b>DM1 - 168 - VCA9 - 95/1L</b>